

Montage - Installation

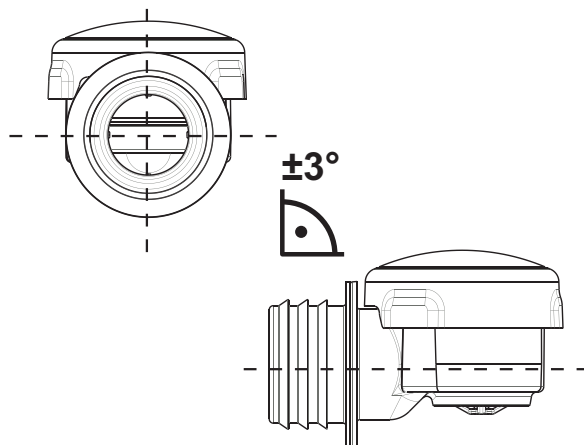

Wartung/Inspektion - Service

1

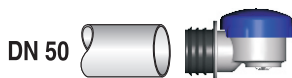
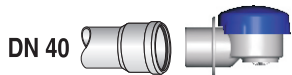
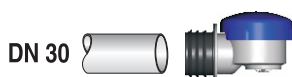
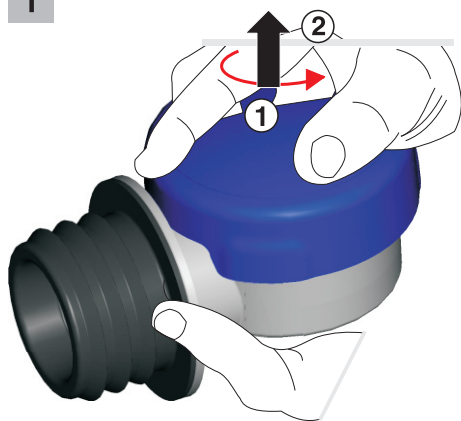

2

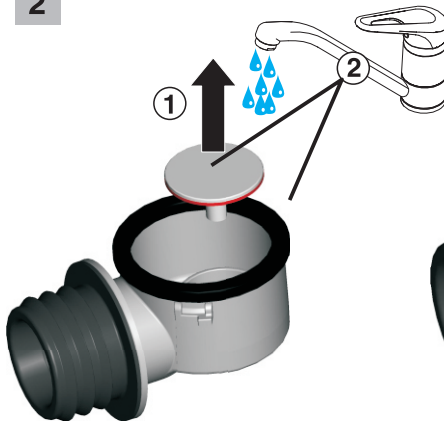

3

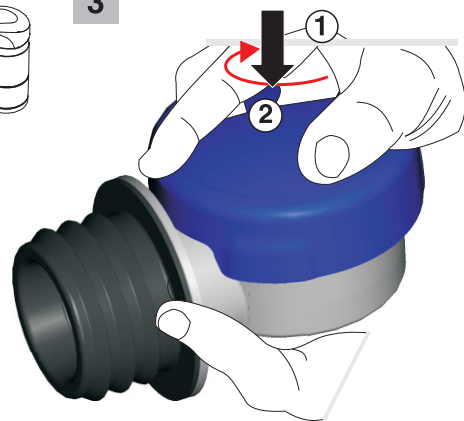

Montage - Installation

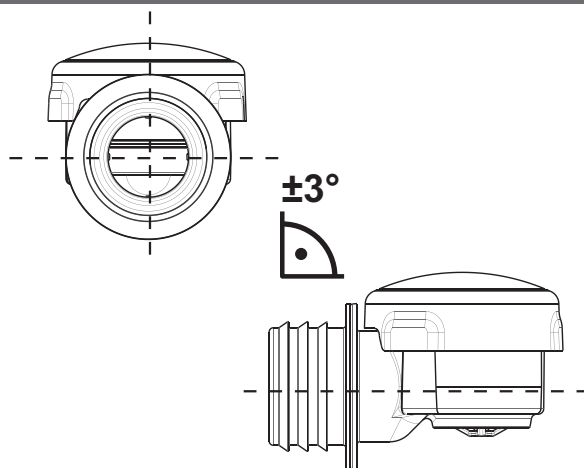
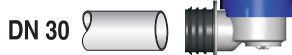

Wartung/Inspektion - Service

1

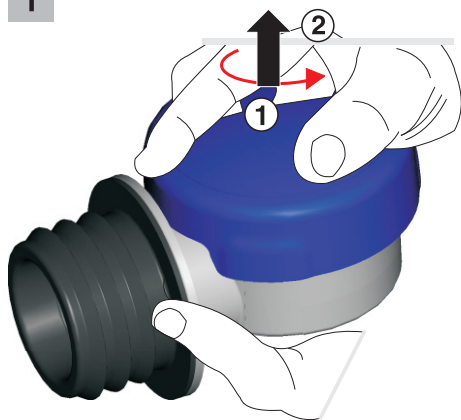

2

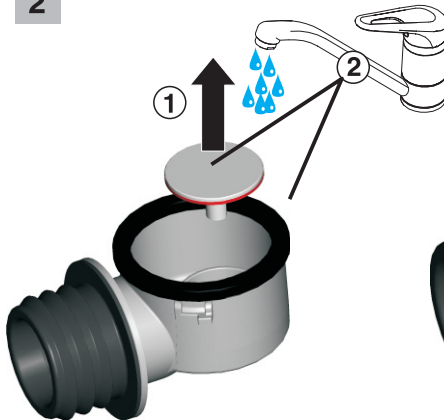

3

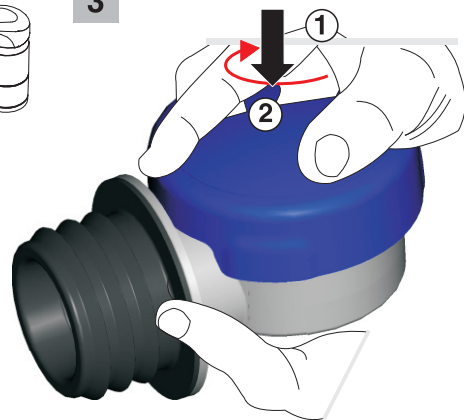

ventilair® waagrecht

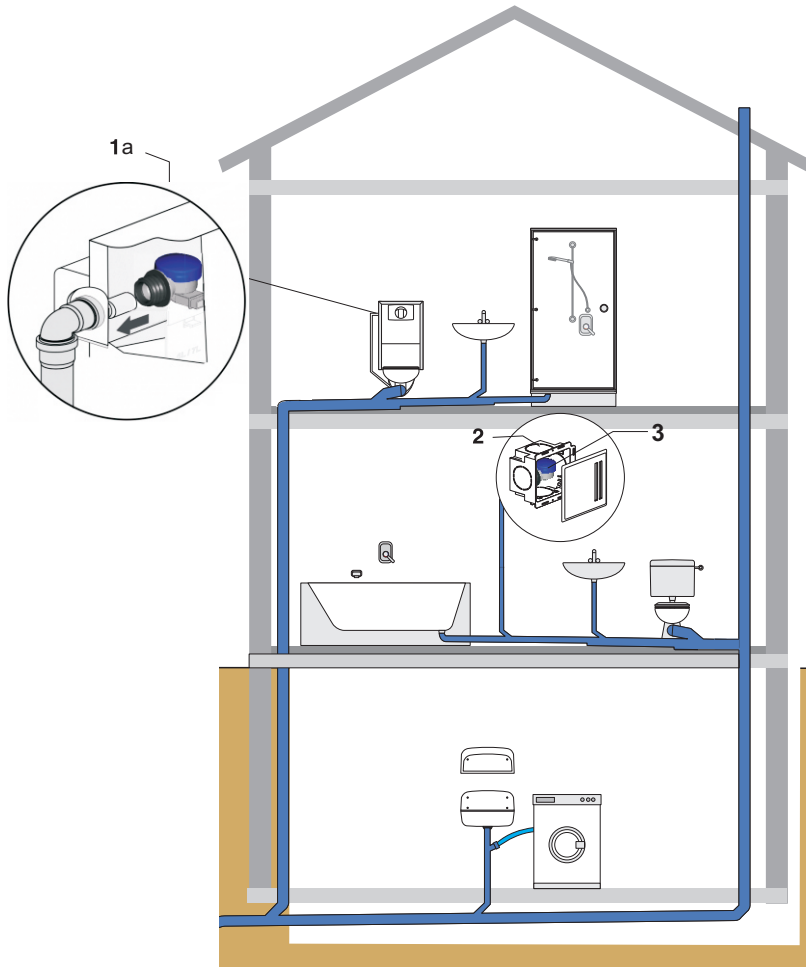

PM.311.67..0000 29.10.2018

1a Art. 90.741.00..0000
WC-Element INEO PLUS 450 mit RBL

1b Art. 11.030.00..0099
Rohrbelüfterinstallationsset für UP-Spülkasten CC-121

2 Art. 17.270.01..S099
RBL-WEBK DN 30-50

3 Art. 11.031.00..0099
RBL waagrecht

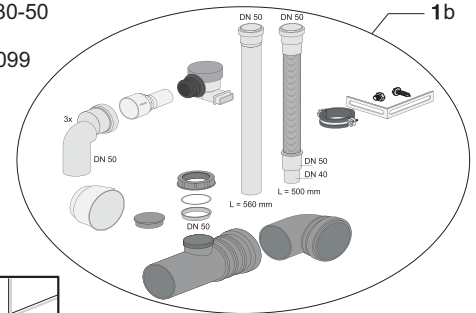

Sanitärtechnik Eisenberg GmbH
Betriebsstätte Rödental
Postfach 1109 · D 96466 Rödental
Am Bahnhof 20 · D 96472 Rödental
Tel. +49(0)9563/930
info@sanit.com · www.sanit.com

ventilair® waagrecht

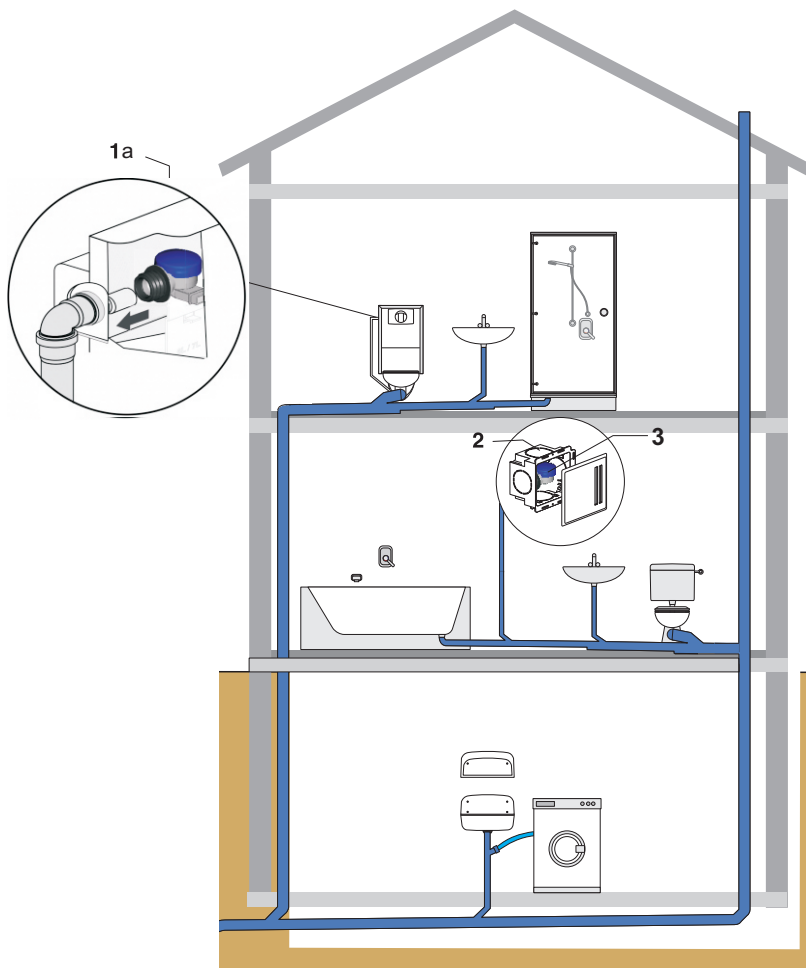

PM.311.67..0000 29.10.2018

1a Art. 90.741.00..0000
WC-Element INEO PLUS 450 mit RBL

1b Art. 11.030.00..0099
Rohrbelüfterinstallationsset für UP-Spülkasten CC-121

2 Art. 17.270.01..S099
RBL-WEBK DN 30-50

3 Art. 11.031.00..0099
RBL waagrecht

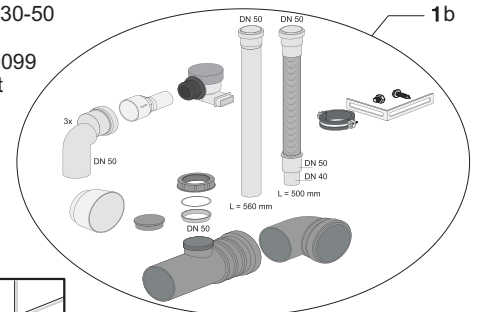

Sanitärtechnik Eisenberg GmbH
Betriebsstätte Rödental
Postfach 1109 · D 96466 Rödental
Am Bahnhof 20 · D 96472 Rödental
Tel. +49(0)9563/930
info@sanit.com · www.sanit.com